



IL 33-DAH-1

Digitrip Retrofit System for Westinghouse DA-75 Breakers

Table of Contents

SAFETY PRECAUTIONS	1
Kit Components List	2
Step 1: General Breaker Preparation	3
Step 2: Removing the Original Electromechanical Trip Units	3
Step 3: Preparing the Sensors	4
Step 4: Installing the Sensors	4
Step 5: Installing the Trip Unit Mounting Platform	5
Step 6: Preparing the Trip Unit Assembly	6
Step 7: Installing the Trip Unit	6
Step 8: Installing the Trip Finger	7
Step 9: Installing the Reset Arm Assembly	7
Step 10: Installing the DTA Assembly	8
Step 11: Installing the 2-Point Terminal Block	9
Step 12: Installing the Breaker Mounted CPT	9
Step 13: Final Connection of the Harnesses and Wiring	11
Step 14: Installing the Auxiliary Switch	14
Step 15: Testing the Breaker	15
Step 16: Mounting the Cell Harness	15
Step 17: Installing the Retrofitted Breaker in the Cell	16
Kit Parts List	17
Torque Values for General Mounting	21
Torque Values for Copper BUS Connectors	21
INDEX	25



Digitrip Retrofit System for Westinghouse DA-75 Breakers

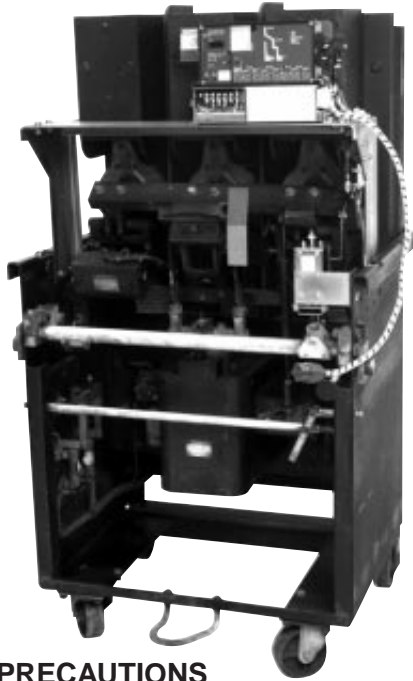

SAFETY PRECAUTIONS



WARNING

POWER CIRCUIT BREAKERS ARE EQUIPPED WITH HIGH SPEED, HIGH ENERGY OPERATING MECHANISMS. THE BREAKERS AND THEIR ENCLOSURES ARE DESIGNED WITH SEVERAL BUILT-IN INTERLOCKS AND SAFETY FEATURES INTENDED TO PROVIDE SAFE AND PROPER OPERATING SEQUENCES. TO PROVIDE MAXIMUM PROTECTION FOR PERSONNEL ASSOCIATED WITH THE INSTALLATION, OPERATION, AND MAINTENANCE OF THESE BREAKERS, THE FOLLOWING PRACTICES MUST BE FOLLOWED. FAILURE TO FOLLOW THESE PRACTICES MAY RESULT IN DEATH, PERSONAL INJURY, OR PROPERTY DAMAGE.

- Only qualified persons, as defined in the National Electric Code, who are familiar with the installation and maintenance of power circuit breakers and their associated switchgear assemblies should perform any work associated with these breakers.

- Completely read and understand all instructions before attempting any installation, operation, maintenance, or modification of these breakers.
- **Always turn off and lock out the power source feeding the breaker prior to attempting any installation, maintenance, or modification of the breaker. Do not use the circuit breaker as the sole means for isolating a high voltage circuit. Follow all lockout and tagging rules of the National Electric Code and all other applicable codes, regulations, and work rules.**
- Do not work on a closed breaker or a breaker with the closing springs charged. Trip (open) the breaker and be sure the stored energy springs are discharged before performing any work. The breaker may trip open or the charging springs may discharge, causing crushing or cutting injuries.
- For drawout breakers, trip (open), and then remove the breaker to a well-lit work area before beginning work.
- Do not perform any maintenance: including breaker charging, closing, tripping, or any other function which could cause significant movement of the breaker while it is on the extension rails. Doing so may cause the breaker to slip from the rails and fall, potentially causing severe personal injury to those in the vicinity.
- **Do not leave the breaker in an intermediate position in the switchgear cell. Always leave it in the connected, disconnected, or (optional) test position. Failure to do so could lead to improper positioning of the breaker and flashover, causing death, serious personal injury, and / or property damage.**
- **Do not defeat any safety interlock. Such interlocks are intended to protect personnel and equipment from damage due to flashover and exposed contacts. Defeating an interlock could lead to death, severe personal injury, and / or property damage.**



Cutler-Hammer Digitrip Retrofit Kits are available in a number of configurations that provide a wide range of features. The Digitrip System starts with the 510 Basic Kit which offers true RMS sensing, overcurrent protection, and self-testing features. Advanced Digitrip Retrofit Kits feature zone interlocking, digital alphanumeric displays, remote alarm signals, IMPACC communications, energy monitoring capabilities, power factors, and harmonic content measurements.

The following table provides a quick reference of the components supplied with each level of Retrofit Kit. Before beginning the Retrofit process, take a minute to review the information contained in the table. It is important that the Retrofitter understand

which level of Retrofit Kit is to be installed and which components are included with the Kit.

The instructions contained in this manual cover the installation of all levels of Retrofit Kit. If the Kit you are installing does not contain a certain component, skip the instructions for that component and proceed to the next.

Throughout the Retrofit process, refer to the Torque Tables at the back of this manual for specific torque values.

If you have any questions concerning the Retrofit Kit and / or the Retrofit process, contact Cutler-Hammer at 1-800-937-5487.

Components	510 Basic	510 with Zone Interlock	610	810	910
Trip Unit					
Rating Plug					
Auxiliary Current Transformer (CT) Module					
Auxiliary CT Harness					
Sensors					
Sensor Harness					
Direct Trip Actuator (DTA)					
Mounting Brackets and Hardware					
External Harness	Plug	1 Connector Harness	2 Connector Harness	4 Connector Harness	4 Connector Harness
Cell Harness					
Breaker Mounted Control Power Transformer (CPT)					
Potential Transformer (PT) Module					
Auxiliary Switch					



Step 1: General Breaker Preparation

Before attempting to remove the Breaker from the cell or perform any Retrofit Operation, be sure to read and understand the Safety Precautions section of this manual. In addition, be sure to read and understand the *Instructions for the Application of Digitrip RMS Retrofit Kits on Power Circuit Breakers* (Retrofit Application Data - Publication AD 33-855-1), supplied with the Digitrip Retrofit Kit.



WARNING

DO NOT ATTEMPT TO INSTALL OR PERFORM MAINTENANCE ON EQUIPMENT WHILE IT IS ENERGIZED. SEVERE PERSONAL INJURY OR DEATH CAN RESULT FROM CONTACT WITH ENERGIZED EQUIPMENT. VERIFY THAT NO VOLTAGE IS PRESENT BEFORE PROCEEDING.

- A. Trip the Breaker and remove it from the Cell. Move the Breaker to a clean, well-lit work bench.

NOTE: It is the responsibility of the Retrofitter to insure that the Breaker and all original components are in good condition. Visually inspect all Breaker components for signs of damage or wear. If any signs of damage or wear are detected for components not included in the Retrofit Kit, secure the necessary replacement parts before beginning the Retrofit Process.

The force necessary to trip the Breaker should not exceed seven (7) lbs.

To begin the Retrofit Process, refer to the components list at the end of this manual. Lay out the components and hardware according to the steps outlined. The components and hardware will be used to complete each step in the Retrofit Process.

Step 2: Removing the Original Electromechanical Trip Units

Follow the Westinghouse DA-75 Instruction Manual, originally supplied with the Breaker, to perform the following procedure.

- A. Remove and scrap the original Electromechanical Trip units and all associated hardware.

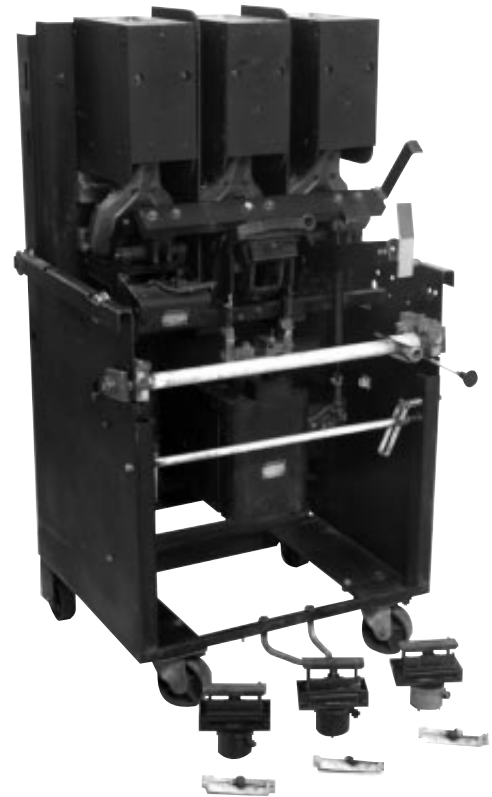



Step 3: Preparing the Sensors



- A. Place each Sensor between two Glass Poly Insulation Plates. The connector stabs should be positioned towards the cutouts in the Insulation Plates as shown.
- B. Secure the Glass Poly Plates on either side of the Sensors using the (12) .250-20 x 2.00" bolts, (24) flat washers, and (12) elastic stop nuts supplied. Note that the bolts must be installed so that the bolt heads will be against the back of the Breaker and the stop nuts away from the Breaker (same side as the screw heads of the Sensor terminals). Do not over tighten the bolts.



Step 4: Installing the Sensors

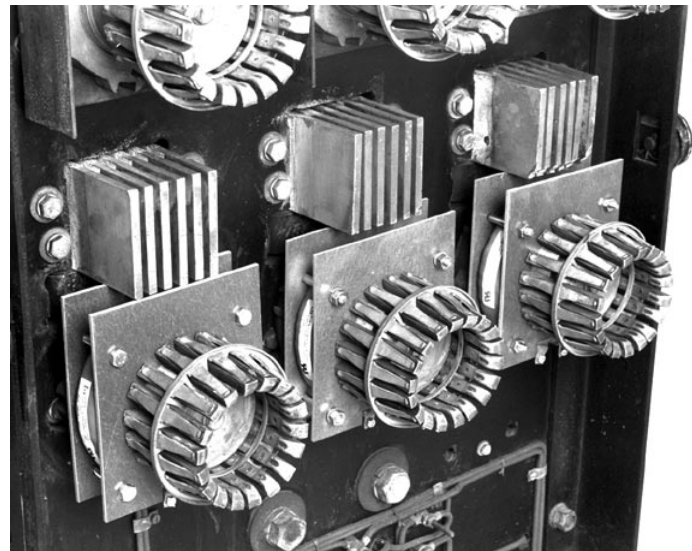

- A. Remove and save the center bolts securing the bottom Finger Clusters to the Breaker Stabs. Remove the Finger Clusters.
- B. Install a Sensor Assembly over each Breaker Stab, with the Sensor terminals pointing downward and the bolt heads outward as shown.
- C. Reinstall the Finger Clusters and secure them using the original hardware.



Step 5: Installing the Trip Unit Mounting Platform



A. Using Drilling Plan "A", drill and counter sink two .375" holes in both the left and right Breaker side plates.

NOTE: The holes for mounting the DTA (see Step 10) should also be drilled and countersunk in the right Breaker Frame at this time.

Drilling Plan "A"

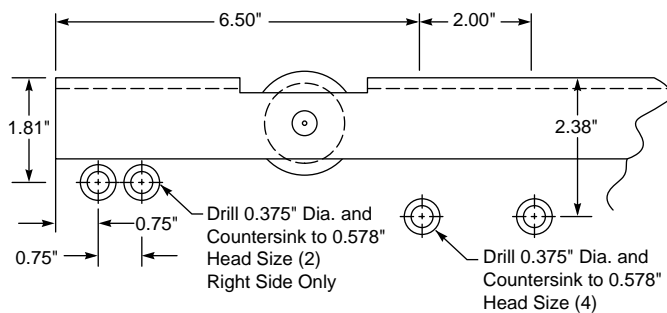

B. Mount the right and left Trip Unit Support Brackets to the Breaker side plates as shown, using the (4) .312-18 x .750" flat head screws, (4) flat washers, (4) lock washers, and (4) nuts supplied. Do not tighten them completely at this time.

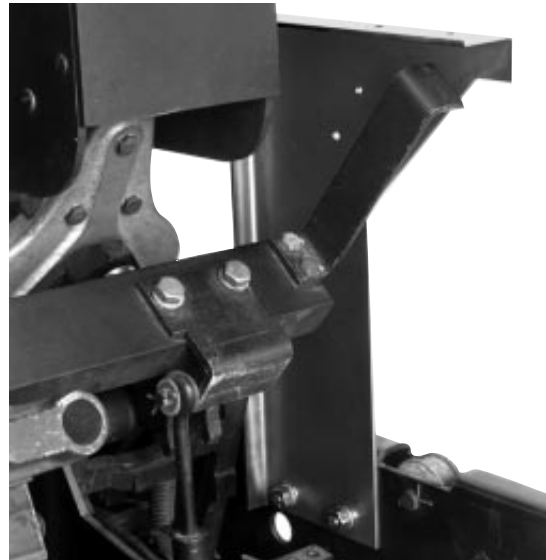

NOTE: For ease of assembly, the 2-Point Terminal Block (Step 11-A) can be mounted to the inside of the right Trip Unit Support Bracket at this time.

C. Mount the Trip Unit Mounting Platform to the Support Brackets using the (4) .312-18 x .750" bolts, (8) flat washers, (4) lock washers, and (4) nuts supplied. Tighten the hardware connecting the Mounting Platform to the Support Brackets, and then the Support Brackets to the Breaker side plates. Assure that the Mounting Platform and Support Brackets are square with the Breaker.



Step 6: Preparing the Trip Unit Assembly



- A. For Kits Supplied with a PT Module Only. Mount the PT Module to the Glass Poly Insulation Barrier as shown, using the (2) .138-32 × .500" screws, (4) flat washers, (2) lock washers, and (2) nuts supplied.



- B. Secure the Glass Poly Insulation Barrier to the back of the Aux. CT Module using the (2) .190-32 × .375" screws, (2) lock washers, and (2) flat washers supplied.
- C. Install the Trip Unit on the top of the Aux. CT Module using the (2) brass spacers, (2) .190-32 × 4.00" screws, (2) lock washers, and (2) flat washers supplied as shown. Note that the brass spacers are placed between the bottom of the Trip Unit and the top of the Aux. CT Module.

- D. Mount the Trip Unit Mounting Brackets to the sides of the Aux. CT Module, using the (4) .190-32 × .375" screws, (4) lock washers, and (4) flat washers supplied, so they "pinch" the Trip Unit in place.



- E. Remove the Trip Unit cover and install the Rating Plug. Replace the cover.
- F. Install the Digitrip Nameplate on the top of the Trip Unit.
- G. Connect the Aux. CT Harness to the Trip Unit and Aux. CT Module.

Step 7: Installing the Trip Unit



- A. Mount the Trip Unit / Aux. CT Module Assembly to the Trip Unit Mounting Platform as shown, using the (4) .250-20 × .750" bolts, (8) flat washers, (4) lock washers, and (4) nuts supplied.



Step 8: Installing the Trip Finger

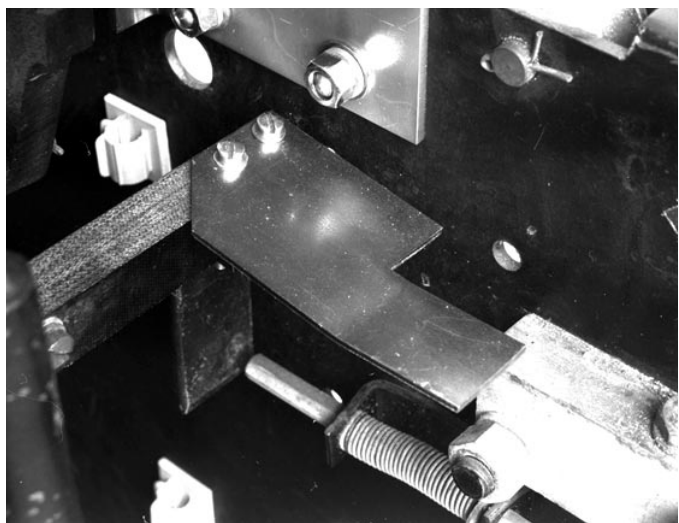

- A. Note the position of the original Trip Finger and associated “gap” between the Trip Finger and manual Trip Shaft. Remove the original Trip Finger and scrap the mounting hardware.
- B. Mount the new Trip Finger on the top of the Cross Bar (with the curve upward and the notch to the right) as shown, and the original Trip Finger back on the bottom of the Cross Bar. Secure using the (2) .190-32 × 1.75" bolts, (4) flat washers, (2) lock washers, and (2) nuts supplied.
- C. Verify that the original Trip Finger has been reinstalled in its initial position by checking the gap (noted in Step 8-A) between the original Trip Finger and manual Trip Shaft.

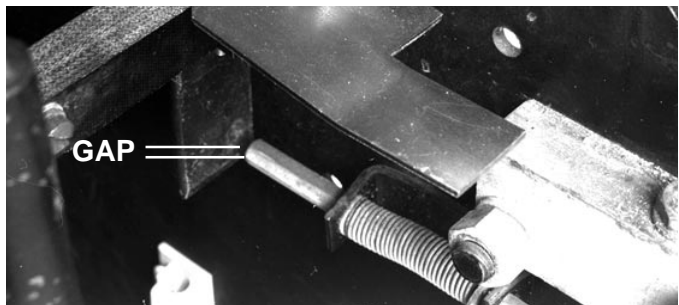

Step 9: Installing the Reset Arm Assembly

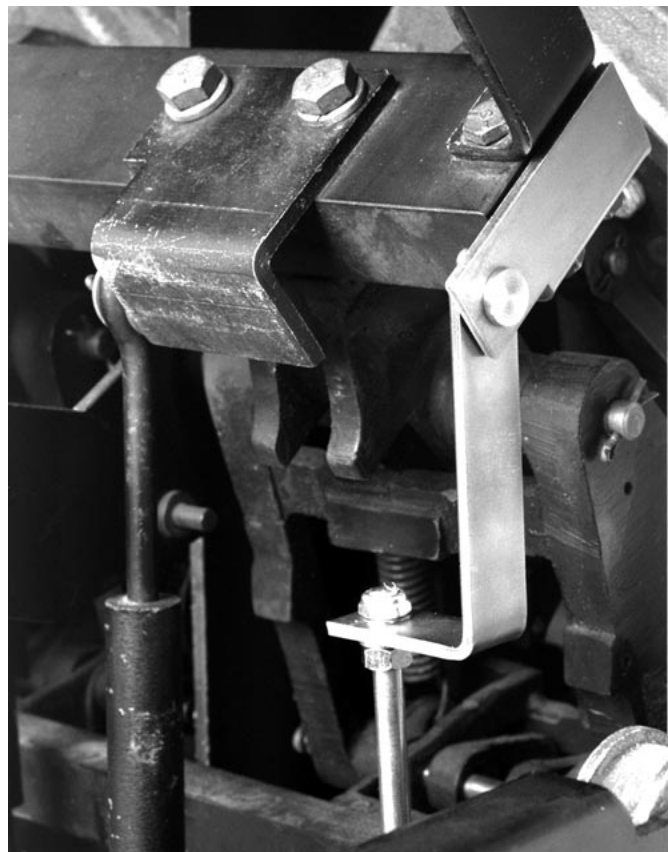

- A. Remove the original Interlock Arm. Scrap the original bolts, washers, and nuts.
- B. Mount the Reset Arm Assembly to the bottom of the Cross Bar and the original Interlock Arm to the top of the Cross Bar in its original position, using the (2) .190-32 × 1.75" bolts, (4) flat washers, (2) lock washers, and (2) nuts supplied. The Reset Arm Assembly should be positioned so that the Reset Arm is hanging downward as shown.

Step 10: Installing the DTA Assembly

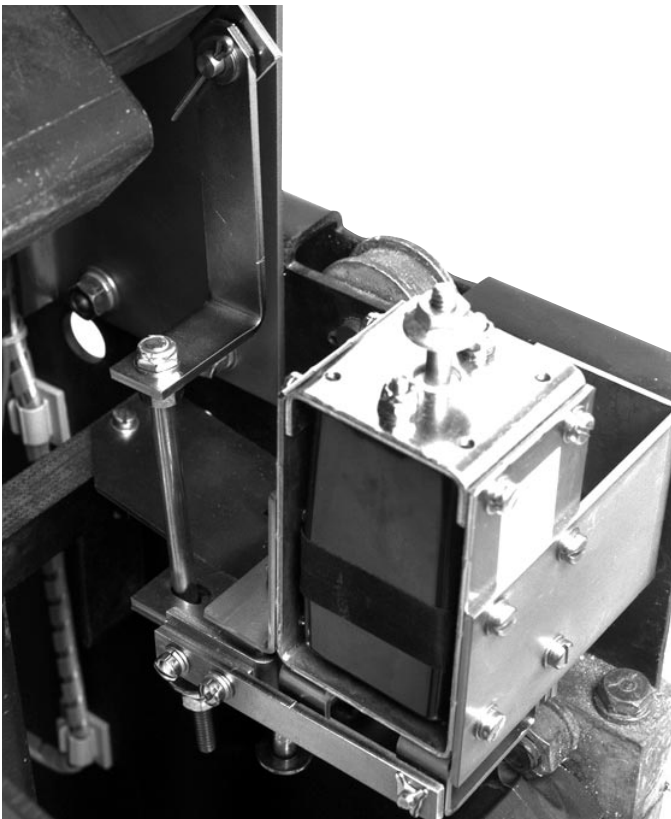

- A. Mount the DTA Mounting Bracket to the right Breaker side panel, as shown, using the holes drilled in Step 5 A and the (2) .312-18 × .750" screws, (2) flat washers, (2) lock washers, and (2) nuts provided.



- B. Remove the two nuts, flat washers, and spring from the Reset Assembly, being careful that the brass spacer does not slide off the all-thread.
- C. Position the DTA Assembly behind the DTA Mounting Bracket, with the Reset Assembly Shaft going through the slot in the DTA Reset Arm. Mount the DTA Assembly to the DTA Mounting Bracket, as shown, using the (4) .164-32 × .312" pan / lock screws and (4) flat washers provided.
- D. With the DTA in the latched position and the DTA Release Arm lifted up over the brass sleeve, reinstall the large flat washer, spring, small flat washer, and (1) nut onto the Reset Assembly Arm. Snug the nut against the brass sleeve.
- E. Apply Loc-Tite® 242 to the threads at the base of the installed nut. Install the second nut and tighten the nuts against each other.

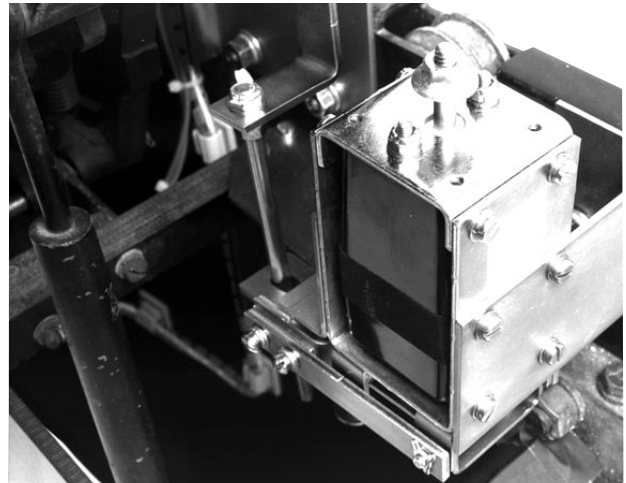

- F. Connect a 24 VDC power supply to the DTA terminals; positive to positive and negative to negative. Close the Breaker manually. Energize the DTA to trip the Breaker; de-energize when the Breaker trips. Make certain that the DTA resets. If the Breaker fails to properly trip or reset, it may be necessary to shorten the brass spacer on the Reset Assembly Shaft. Make the necessary adjustments until the trips and resets are sure and positive each time.



Step 11: Installing the 2-Point Terminal Block



- A. Mount the 2-Point Terminal Block to the pre-drilled holes in the right Trip Unit Support Bracket as shown, using the (2) .138-32 x .750" screws, (4) flat washers, (2) lock washers, and (2) nuts supplied.
- B. Route the DTA wires from the DTA Assembly to the 2-Point Terminal Block. After assuring the wires are clear of any moving components within the Breaker, connect the DTA wires to the 2-Point Terminal Block.

For Kits Supplied with a Breaker Mounted CPT Only.

Step 12: Installing the Breaker Mounted CPT



- A. Align the holes in the Breaker Mounted CPT with the predrilled holes on the left side of the Trip Unit Mounting Platform. Secure the CPT to the Trip Unit Mounting Platform using the (4) .190-32 x .500" screws, (8) flat washers, (4) lock washers, and (4) nuts supplied. Note that the X1 and X2 terminals face the front of the Breaker.



- B. Insert the black plug of the CPT Harness into the receptacle in the Trip Unit.

- C. Route the CPT Harness between the Trip Unit and the Insulation Barrier to the CPT. Strip .250" of insulation and attach a .138" ring terminal to each wire of the CPT Harness. Connect the CPT Harness wires to the X1 and X2 terminals of the CPT.
- D. Position the fuses on the High Voltage (HV) Wires in an accessible location. Route the HV Wires between the Trip Unit and Insulation Barrier to the Breaker Mounted CPT, then cut the Load Side of each HV Wire to an appropriate length. Strip .250" from the Load Side HV Wires and attach a .138" ring terminal to each. Attach the HV Wires to the CPT terminals to achieve the required voltage (see the following table). The HV Wires will be connected to the Phase Frames later in the Retrofit process.

- E. Attach the Glass Poly Insulation Plate to the top of the CPT, as shown, using the screws and lock washers supplied with the CPT kit.

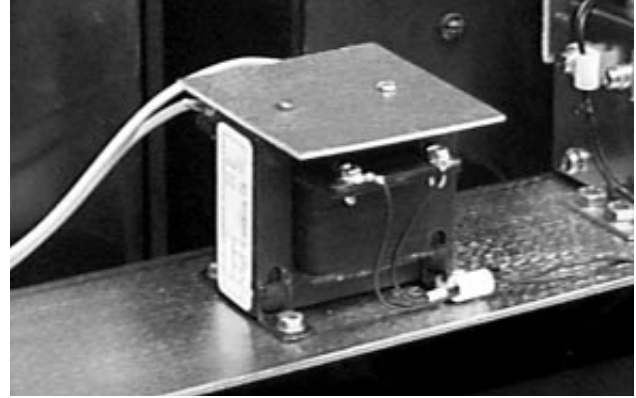

- F. Attach the appropriate warning label for the Breaker to the left of the CPT on the Trip Unit Mounting Platform.

Voltage Required 600 Volt Circuit	CPT Terminals Used H1 & H2
Voltage Required 480 Volt Circuit	CPT Terminals Used H1 & H4
240 Volt Circuit	H1 & H3
208 Volt Circuit	H1 & H2

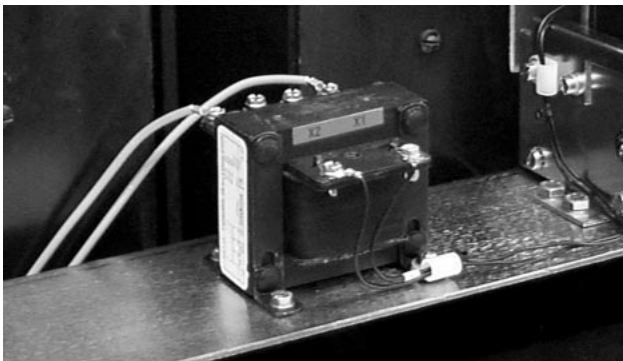



Step 13: Final Connection of the Harnesses and Wiring



- A. Feed the Sensor Harness through the hole in the left side of the Aux. CT Module. Connect the Sensor Harness to the proper terminals on the Aux. CT Module. Refer to Section 12 of the Retrofit Application Data, supplied with the Retrofit Kit, for detailed wiring specifications.

Connect the green ground wire from the Sensor Harness (with the ring terminal) to the screw in the left side of the Aux. CT Module.

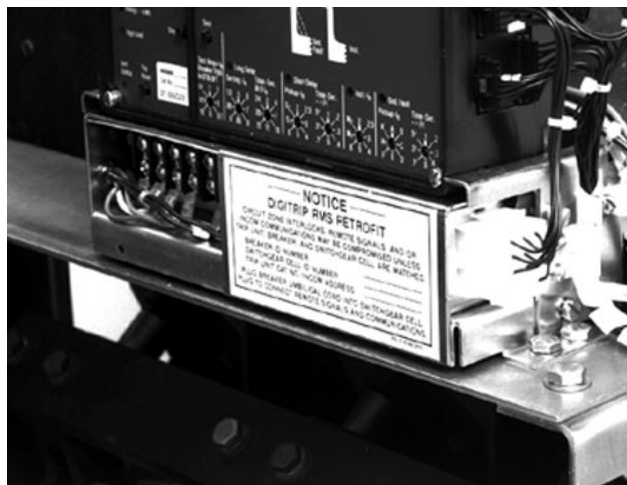

- B. Route the Sensor Harness between the Glass Poly Insulation Barrier and the back of the Trip Unit, then down along the right Trip Unit Mounting Bracket and through the hole in the Breaker Back Plate as shown. Secure the Sensor Harness as shown using the wire clamps and (6) .138-20 x .500" thread cutting screws supplied.

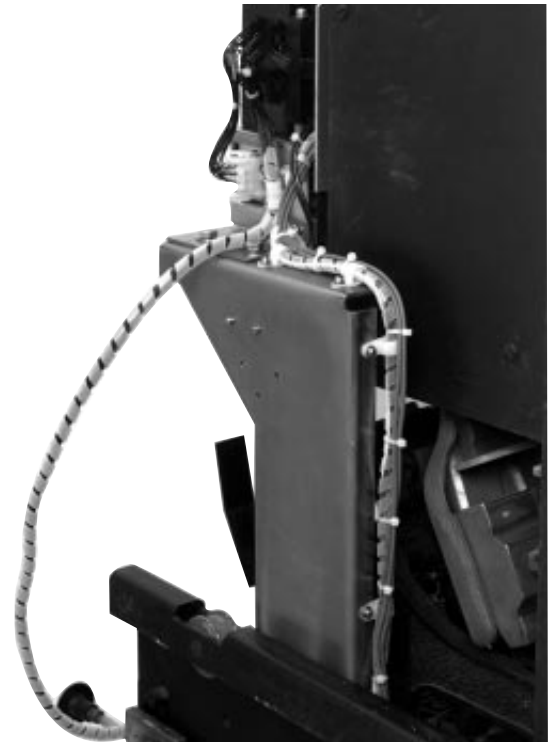

- C. Route the Sensor Harness to the bottom of the Sensors. Connect the ring terminals of the Sensor Harness to the Sensors. Refer to Section 12 of the Retrofit Application Data, supplied with the Retrofit Kit, for detailed wiring specifications.

Depending on the Sensors supplied with the Retrofit Kit, the following convention applies.

Sensor Style No.

4A35613H01

X1-X2 = 3000 A

- D. *For Kits Supplied with a PT Module Only.* Refer to Section 7-3, Power Flow Convention of the Retrofit Application Data, supplied with the Retrofit Kit for additional wiring information and to verify the Phase Convention used on this Breaker Application.

Route the PT Wires between the Glass Poly Insulation Barrier and the back of the Trip Unit, then down along the right Trip Unit Mounting Bracket to the area where the original Electromechanical Trip devices were removed (Step 2).

The PT Wires are marked for connection to Phases 1, 2, and 3 with corresponding numbers.

NOTE: Before cutting the PT Wires, verify the Phase Convention used on the Breaker Application.

Route the PT Wires to a position suitable for attachment to the proper Breaker Phase Frames. Move the PT Wire markers to a position where they will still be attached to the wires after cutting. Cut the wires to length, strip each wire .250", and install a .250" ring terminal to each PT Wire.

Connect each PT Wire to the corresponding Breaker Phase Frames using the (3) .250-20 × .500" bolts, (3) lock washers, and (3) flat washers supplied.

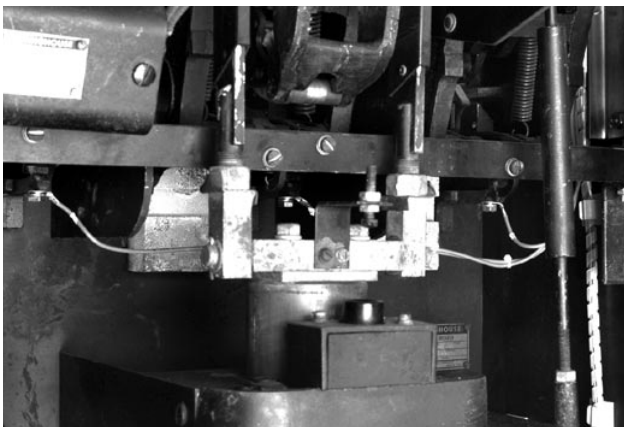

- E. *For Kits Supplied with a Breaker Mounted CPT Only.* Route the *Line Side* HV Wires to the rear of the Breaker through the opening in the Breaker Back Plate and along the rear of the Breaker to the top Phase Frames.

Note: The power convention of the Westinghouse DA-75 Series Breakers is normally *Top to Bottom*, meaning the Top Breaker Phase Frames are on the *Line Side* of the Breaker and the Bottom Breaker Stabs are on the *Load Side*.

The HV Wires from the CPT MUST BE ATTACHED to the *Line Side* of the Breaker. If it is determined that the power flow for the Breaker application is opposite the normal convention, the HV Wires must be attached to the Bottom Phase Frames. The bolts used to secure the PT Wires can be used to connect the HV Wires.

Note: The *Line Side* HV Wires are longer than necessary and are cut during the following steps. Before cutting the wires, be sure that sufficient length is left so that the connections can be made to the correct Finger Clusters or Phase Frames.

- F. *For Kits Supplied with a Breaker Mounted CPT Only.* Using a .234" drill, drill and tap one hole in the top of the Phase 1 and 2 or Phase 2 and 3 Phase Frames.
- G. *For Kits Supplied with a Breaker Mounted CPT Only.* Cut the HV Wires to the appropriate length for attachment to the appropriate Phase Frames. Strip .250" from each HV Wire and attach a .250" ring terminal. Using the (2) .250-20 × .500" bolts, (2) flat washers, and (2) lock washers supplied, connect the HV Wires to the appropriate Phase Frames.

- H. Feed the two wires from the DTA Extension Harness through the opening in the left side of the Aux. CT Module. Connect the wire marked “+” to the “OP” terminal and the unmarked wire to the “ON” terminal.
- I. Route the DTA Extension Harness between the Glass Poly Insulation Barrier and the back of the Trip Unit, then down along the right Trip Unit Support Bracket to the 2-Point Terminal Block. Connect the wire from the DTA Extension Harness marked with “+” to the “+” terminal and the unmarked wire to the other terminal.



NOTE: For 510 Basic Retrofit Kits, the External Harness is the plug pictured above. It is to be plugged into the right side of the Trip Unit.

- K. *For Kits Supplied with a PT Module Only.* Connect the PT Harness to the External Harness.

- L. Use the wire ties, wire clamps, and self adhesive wire clips provided to dress all wires and harnesses to keep them away from any moving parts within the Breaker.

NOTE: The self adhesive wire clips should be attached to the right Breaker side panel to secure the Sensor Harness. The wire clamps should be attached to the hardware mounting the Aux. CT Module and the Trip Unit, as shown, to secure the Sensor Harness, External Harness, and PT Extension Harness.



- J. Connect the External Harness to the Trip Unit.

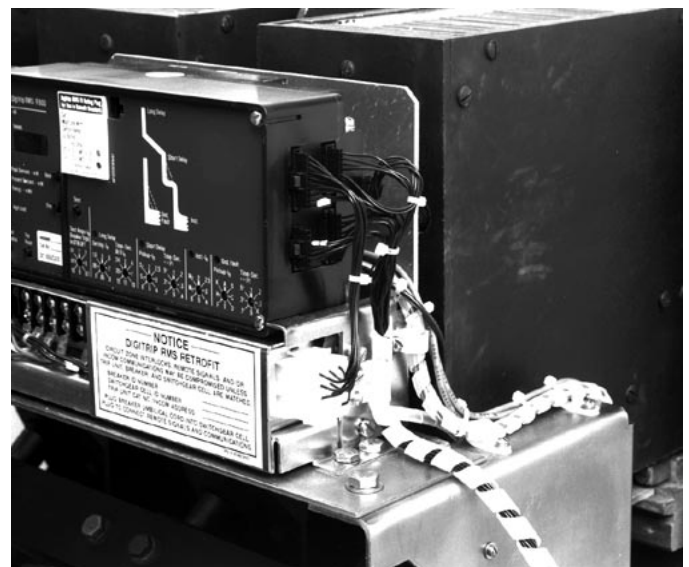
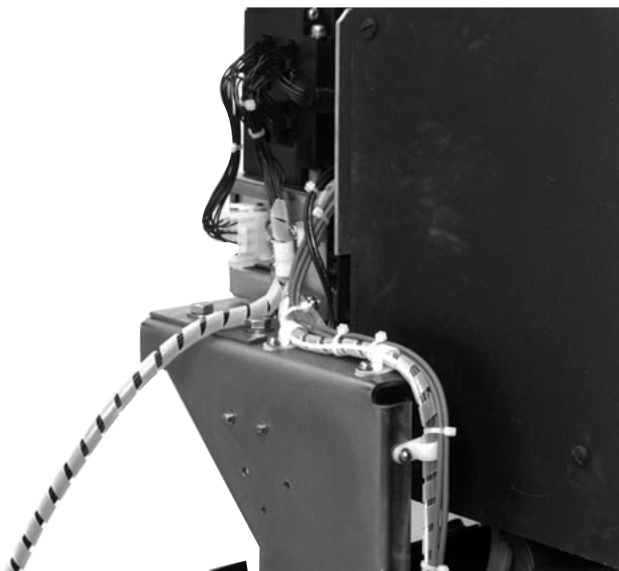



For Kits Supplied with an Aux. Switch Only.

Step 14: Installing the Auxiliary Switch

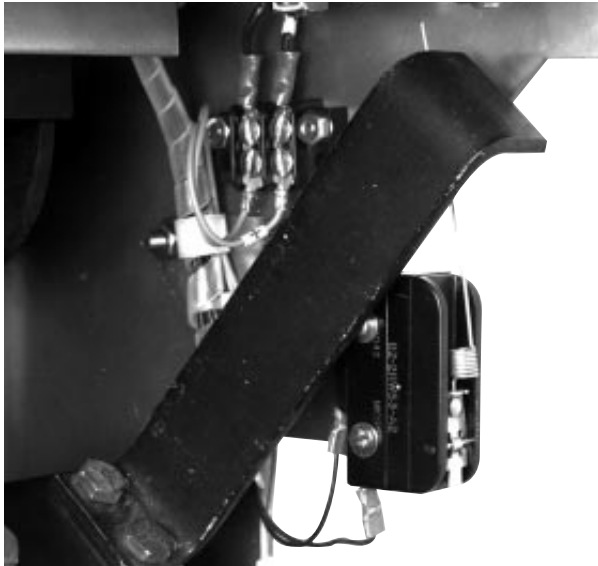

- A. Using diagonals, cut 2.625" off the Microswitch Arm.
- B. Mount the Microswitch to the Auxiliary Switch Mounting Bracket, as shown, using the (2) .138-32 x 1.25" screws, (8) flat washers, (4) lock washers, and (4) nuts supplied.

NOTE: To provide correct spacing, the hardware must be installed in the following order. Insert screws with flat washers installed through the switch. Install flat washers, lock washers, and tighten the nuts. Install another set of flat washers, then the mounting bracket, flat washers, lock washers, and nuts.

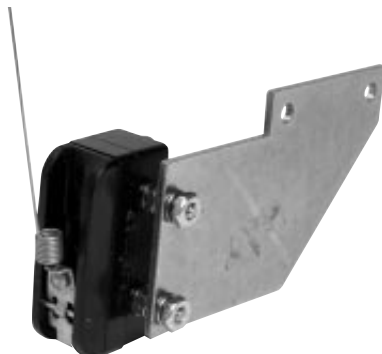

- C. Connect the two wires (with ring terminals) from the External Harness to the Auxiliary Switch. Connect one wire to the normally "Open" terminal and the other wire to the "Common" terminal of the Auxiliary Switch.
- D. Making sure the Microswitch arm is behind the Interlock Bar, mount the Aux. Switch Assembly to the pre-drilled holes in the right Trip Unit Mounting Bracket, using the (2) .164-32 x .500" screws, (4) flat washers, (2) lock washers, and (2) nuts supplied.

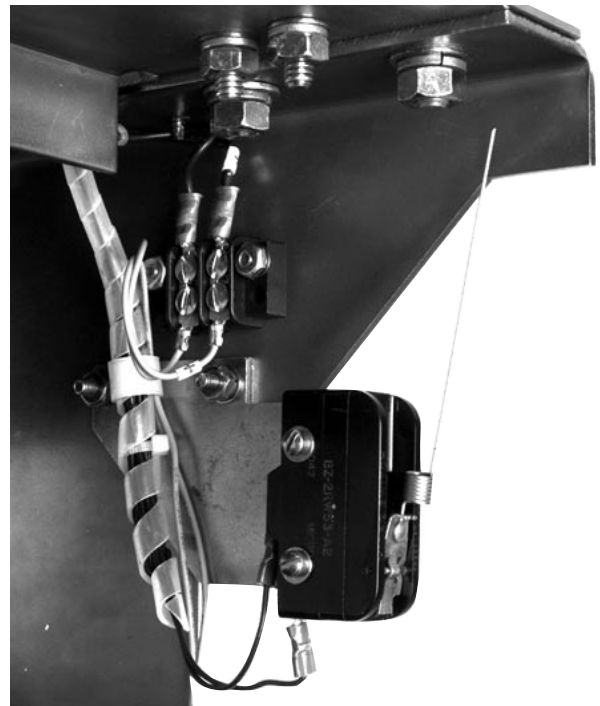

Step 15: Testing the Breaker

- A. Measure the force necessary to trip the Breaker at the point where the DTA impacts the Trip Finger. The force necessary to trip the Breaker **MUST NOT EXCEED SEVEN (7) lbs.**
- B. The Retrofit must be tested using primary injection. Refer to Section 8 of the *Instructions for the Application of Digitrip RMS Retrofit Kits on Power Circuit Breakers* (Publication AD 33-855-1, June, 1997), supplied with the Retrofit Kit, for detailed testing procedures and specifications. For test information specific to the Trip Unit, refer to the IL publication supplied with the Retrofit Kit (see the Pick List for the IL number).
- C. While Section 8 of the *Instructions for the Application of Digitrip RMS Retrofit Kits on Power Circuit Breakers* provides the information necessary for testing the Breaker, please keep the following notes in mind when reviewing other sections of the publication.

CAUTION: When all testing is complete, the Trip Unit must be reset. Failure to do so may cause the battery in the Rating plug to run down.

Notes:

1. **Publication AD-33-855 was created specifically for the “hundred” series (500, 600, 700, etc.) Retrofit Kits. Therefore certain sections and figures do not apply to the “ten” series (510, 610, 810, etc.) Retrofit Kits. Specifically, these are Sections 13 and 14, as well as Figures 3-2, 3-3, and 3-4.**
 2. **For All Kits Other Than 510 Basic.** If testing the Breaker with Short Delay or Ground Fault functions, be sure to either plug in the Cell Harness Assembly or use the Zone Interlock Shorting Plug. Failure to do so may result in shorter than expected trip times.
3. **For 810 and 910 Kits Only.** Without any power applied to the system (neither the 120 volt power supply nor the Aux. Power Module connected), plug the External Harness into the Cell Harness and check the impedance between COM 1 and COM 2. The impedance should be between one (1) and three (3) ohms. If the impedance is not within this range, trace the wiring and examine each connection to assure its integrity.

Confirm that the IMPACC communication wiring is correct by following the procedures detailed in Section 7.4 of the Instructions for the Application of Digitrip RMS Retrofit Kits on Power Circuit Breakers. Note that for 810 and 910 Kits, the impedance between COM 1 and COM 2 should be between one (1) and three (3) ohms.

When testing is complete, disconnect the External Harness from the Cell Harness. Final External Harness connection will be performed in Step 16.

For Kits Supplied with a Cell Harness Only.

Step 16: Mounting the Cell Harness

- A. The Cell Harness is to be mounted in the Breaker Cell. The connector end is to be mounted on the right front side of the Cell, in a location suitable for connection with the External Harness. The Terminal Blocks can be mounted anywhere space is available in the Cell as long as connection to the External Harness can be made.
- B. Route the Cell Harness wiring to keep it away from any moving parts within the Cell Housing.

Step 17: Installing the Retrofitted Breaker in the Cell



WARNING

Do not leave the Breaker in an intermediate position in the switchgear cell. Always leave it in the **CONNECTED**, **DISCONNECTED**, or (Optional) **TEST** position. Failure to do so could lead to improper positioning of the Breaker and flashover, causing death, serious personal injury, and / or property damage.



WARNING

It is solely the responsibility of the Retrofitter to make the necessary modifications to the original Racking Mechanism, or to manufacture a Racking Bar Adapter, to insure safe racking of the Breaker into the Cell. If the Retrofitter opts to modify the original Racking Mechanism, the Racking Bar Receptacle must be removed from the Racking Mechanism, moved to a location where the Racking Bar will not contact the DTA during racking, and welded to the Racking Mechanism.

If the Retrofitter opts to manufacture a Racking Bar Adapter for use with the original Racking Mechanism configuration, the drawing and photo below should be used as a basis.

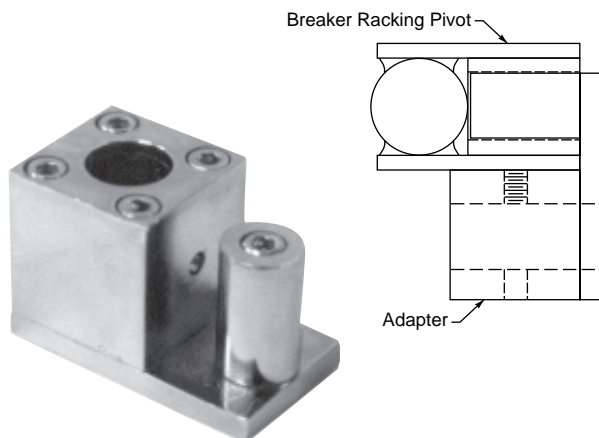

NOTE: It is the responsibility of the Retrofitter to insure proper Breaker / Cell fit. When racking the Breaker into the Connected position, the Retrofitter **MUST FOLLOW BOTH** the manufacturer's instructions and the customer's safety standards and procedures for racking a Breaker into the Connected position.

- A. With the Breaker in the Open position and the springs discharged, slowly rack the Breaker into the Connected position, making sure there is no interference or binding. The Breaker should rack smoothly and without mechanical interference between any Breaker and Cell parts. The Retrofitter will feel some resistance when the primary fingers connect onto the stabs of the Cell. This is normal.

However, if any unusual resistance is detected that could be abnormal interference between the Breaker and Cell parts, stop immediately and move the Breaker out of the Connected position. Examine what is causing the interference and correct the situation.



Digitrip Retrofit Kit Installation Components for the Westinghouse DA-75 Breakers

Step	Description	Style No.	Qty.	Comment
Step 3	Sensors 3000/5000	4A35613H01	3	
	Sensor Mounting Parts	4A35618G04	1	
	Glass Poly Mounting Plates		6	
	.250 - 20 × 2.00 Lng. Hex Bolt		12	
	.250 Flat Washer Stl.		24	
	.250 - 20 Elastic Stop Nut		12	
Step 5	Trip Unit Mounting Platform Parts	4A35618G05	1	
	Trip Unit Support Bracket R. H.		1	
	Trip Unit Support Bracket L. H.		1	
	Trip Unit Mounting Platform		1	
	.312 - 18 × .750 Lng. Screw Flat		4	
	.312 - 18 × .750 Lng. Hex Bolt		4	
	.312 Flat Washer Stl.		12	
	.312 Lock Washer Stl.		8	
	.312 - 18 Nut Hex Stl.		8	
Step 6	Trip Unit		1	See Pick List
	Rating Plug		1	See Pick List
	Aux. CT Module	6502C78G__	1	
	Aux. CT Harness	6502C84G01	1	
	Trip Unit Assembly Parts	4A35618G07	1	
	Mounting Bracket L. H.		1	
	Mounting Bracket R. H.		1	
	Barrier		1	
	Digitrip Nameplate		1	
	Spacer Brass		2	
	.190 - 32 × 4.00 Lng. Screw Fil.		2	
	.190 - 32 × .375 Lng. Screw Fil.		6	
	.190 Flat Washer Stl.		8	
	.190 Lock Washer Stl.		8	
	PT Module Kit	6502C82G01	1	} Comm. Only
	.138-32 × .500 Lng. Screw		2	
	.138 Flat Washer		4	
.138 Lock Washer		2		
.138-32 Nut Hex Stl.		2		
Ring Terminals (.190, .250, .312, .375, .500), 3 Each Size		5		

Digitrip Retrofit Kit Installation Components for the Westinghouse DA-75 Breakers (Continued)

Step	Description	Style No.	Qty.	Comment
Step 7	Trip Unit Assembly (From Step 6)			
	Trip Unit Mounting Hardware	4A35618G08	1	
	.250 - 20 × .750 Lng. Hex Bolt		4	
	.250 Flat Washer Stl.		8	
	.250 Lock Washer Stl.		4	
	.250 - 20 Nut Hex Stl.		4	
Step 8	Breaker Trip Finger Parts	4A35618G09	1	
	Trip Finger		1	
	.190-32 × 1.75 Lng. Screw Fil.		2	
	.190 Flat Washer Stl.		4	
	.190 Lock Washer Stl.		2	
	.190 - 32 Nut Hex Stl.		2	
Step 9	Breaker Reset Parts	4A35618G10	1	
	Reset Assembly		1	
	.250 - 20 × 1.75 Lng. Hex Bolt		2	
	.250 Flat Washer Stl.		4	
	.250 Lock Washer Stl.		2	
	.250 - 20 Nut Hex Stl.		2	
Step 10	DTA Assembly Parts	4A35618G11	1	
	High Force Trip Actuator	4A35618G33	1	
	DTA Mounting Hardware	4A35618G12	1	
	Mounting Bracket		1	
	.312 - 18 × .750 Lng. Screw Flat		2	
	.312 Flat Washer Stl.		2	
	.312 Lock Washer Stl.		2	
	.312 - 18 Nut Hex Stl.		2	
	.164 - 32 × .312 Lng. Screw Pan Lock		4	
	.164 Flat Washer Stl.		4	
	Loc-Tite® 242		1	
Step 11	Terminal Block Parts	4A35618G13	1	
	2-Point Terminal Block		1	
	.138 - 32 × .750 Lng. Screw Fil.		2	
	.138 Flat Washer Stl.		4	
	.138 Lock Washer Stl.		2	
	.138 - 32 Nut Hex Stl.		2	

Digitrip Retrofit Kit Installation Components for the Westinghouse DA-75 Breakers (Continued)

Step	Description	Style No.	Qty.	Comment	
Step 12	Breaker Mounted CPT Kit	8259A91G05	1	CPT Only	
	Ring Terminals (.138, .190, .250, .312, .375, .500)		2	Each Size CPT Only	
	CPT Mounting Parts	4A35618G20	1	CPT Only	
	Glass Poly Insulation Plate		1		
	.190-32 × .500 Lng. Screw Fil.		4		
	.190 Flat Washer Stl.		8		
	.190 Lock Washer Stl.		4		
	.190-32 Nut Hex Stl.		4		
	.250-20 × .500 Lng. Hex Bolt		2		
	.250 Flat Washer Stl.		2		
	.250 Lock Washer Stl.		2		
	Warning Label (208, 240, 480, & 600 Volt - 1 each)		1		
	Step 13	Sensor Harness		1	
		Sensor Harness Parts	4A35618G14	1	
Wire Clamp Nylon			6		
.138 - 20 × .500 Lng. Screw T. C.			6		
.138 Flat Washer Stl.			6		
.138 Lock Washer Stl.			6		
Wire Clip			4	} Comm. Only	
.250 - 20 × .500 Lng. Hex Bolt			3		
.250 Flat Washer Stl.			3		
.250 Lock Washer Stl.			3	} From Step 12	
.250-20 × .500 Lng. Hex Bolt			2		
.250 Flat Washer Stl.			2		
.250 Lock Washer Stl.			2		
DTA Extension Harness		6503C83G01	1		
External Harness	6502C83G0__	1			
External Harness Parts	4A35618G15	1			
Wire Clamp Nylon		4			

Wire Tie Nylon

10

Digitrip Retrofit Kit Installation Components for the Westinghouse DA-75 Breakers (Continued)

Step	Description	Style No.	Qty.	Comment
Step 14	Aux. Switch Kit	4A35618G02	1	} Comm. Only
	Microswitch		1	
	Mounting Bracket		1	
	.164 - 32 × .500 Lng. Screw Fil.		2	
	.164 Flat Washer Stl.		4	
	.164 Lock Washer Stl.		2	
	.164 - 32 Nut Hex Stl.		2	
	.138 - 32 × 1.25 Lng. Screw Fil.		2	
	.138 Flat Washer Stl.		8	
	.138 Lock Washer Stl.		4	
	.138 - 32 Nut Hex Stl.		4	
Step 15	Cell Harness	6503C57G__	1	Except 510 Basics

NOTE: Due to the wide vintage of breakers and the multiple functions of the Retrofit components, some excess hardware may remain when the Retrofit is complete.



Torque Values for General Mounting

Decimal Size (in)	Standard Size	Torque (in-lbs)	Torque (ft-lbs)
.112	4-40	10	0.8
.138	6-32	18	1.5
.164	8-32	36	3.0
.190	10-32	46	3.8
.250	1/4-20	100	8.3
.312	5/16-18	206	17.2
.375	3/8-16	356	29.7
.438	7/16-14	572	47.7
.500	1/2-13	856	71.3

Torque Values for Copper BUS Connectors

Decimal Size (in)	Standard Size	Torque (in-lbs)	Torque (ft-lbs)
.250	1/4-20	60	5
.312	5/16-18	144	12
.375	3/8-16	240	20
.500	1/2-13	600	50

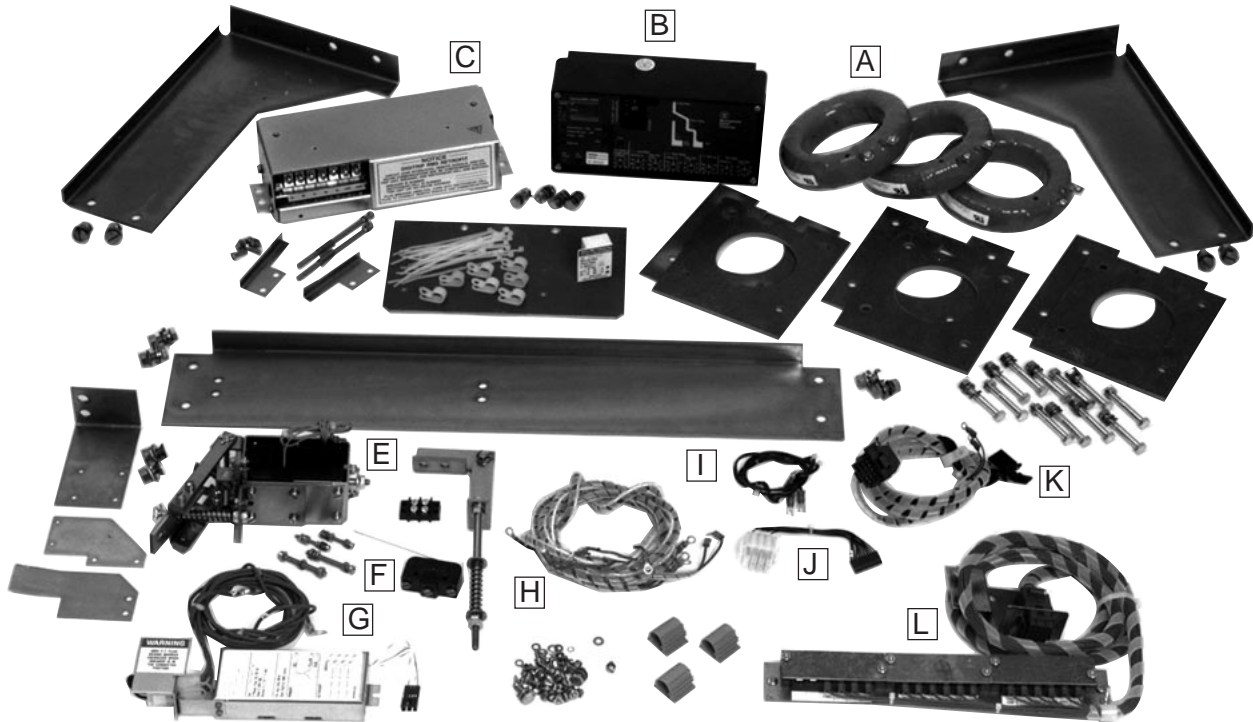

- A. Sensors
- B. Trip Unit
- C. Aux. CT Module
- D. Rating Plug
- E. Direct Trip Actuator (DTA)
- F. Aux. Switch
- G. PT Module
- H. Sensor Harness
- I. DTA Extension Harness
- J. Aux. CT Harness
- K. External Harness
- L. Cell Terminal Block Assembly

CPT Kit not pictured.

Notes:

We wish to thank you for purchasing the Digitrip Retrofit System. Digitrip Retrofit Kits are designed and manufactured in America with pride. All the components are engineered to fit the existing Circuit Breaker with little or no modifications to the existing Breaker. However due to the wide variety and vintage of Breakers in use today, an occasional problem may arise. Please contact us with any questions, comments or concerns.

Phone: **1-800-937-5487** Fax. (724) 779-5899

The instructions for installation, testing, maintenance, or repair herein are provided for the use of the product in general commercial applications and may not be appropriate for use in nuclear applications. Additional instructions may be available upon specific request to replace, amend, or supplement these instructions to qualify them for use with the product in safety-related applications in a nuclear facility.

The information, recommendations, descriptions, and safety notations in this document are based on Cutler-Hammer's experience and judgement with respect to retrofitting of power breakers. This information should not be considered to be all inclusive or covering all contingencies. If further information is required, Cutler-Hammer should be consulted.

NO WARRANTIES, EXPRESSED OR IMPLIED, INCLUDING WARRANTIES OF FITNESS FOR A PARTICULAR PURPOSE OR MERCHANTABILITY, OR WARRANTIES ARISING FROM COURSE OF DEALING OR USAGE OF TRADE, ARE MADE REGARDING THE INFORMATION, RECOMMENDATIONS AND DESCRIPTIONS CONTAINED HEREIN. In no event will Cutler-Hammer be responsible to the user in contract, in tort (including negligence), strict liability or otherwise, for any special, indirect, incidental, or consequential damage or loss whatsoever, including but not limited to damage to or loss of use of equipment, plant or power system, cost of capital, loss of profits or revenues, cost of replacement power, additional expenses in the use of existing power facilities, or claims against the user by its customers resulting from the use of the information, recommendations, and descriptions contained herein.

Cutler-Hammer

130 Commonwealth Drive
Warrendale, PA 15086

INDEX

Symbols

2-Point Terminal Block 9
510 Basic Retrofit Kits 13

A

Auxiliary Switch 14

B

Breaker Mounted CPT 9

C

Cell Harness 15
CPT Terminals 10

D

Drilling Plan "A" 5
DTA Assembly 8
DTA Extension Harness 13

F

Final Connection of the Harnesses and Wiring 11

G

General Breaker Preparation 3
Glass Poly Insulation Plate 10

H

HV Wires 12

I

Installing the 2-Point Terminal Block 9
Installing the Auxiliary Switch 14
Installing the Breaker Mounted CPT 9
Installing the DTA Assembly 8
Installing the Reset Arm Assembly 7
Installing the Retrofitted Breaker in the Cell 16
Installing the Sensors 4
Installing the Trip Finger 7
Installing the Trip Unit 6
Installing the Trip Unit Mounting Platform 5

K

Kit Components Table 1

M

Mounting the Cell Harness 15

P

Phase Convention 12
PT Wires 12

R

Racking Bar Adapter 16
Removing the Original Electromechanical Trip Units 3
Reset Arm Assembly 7
Retrofit Kit Installation Components 17
Retrofitted Breaker 16

S

SAFETY PRECAUTIONS 1
Sensor Style No. 11
Sensors 4

T

Testing the Breaker 15
Torque Values for Copper BUS Connectors 21
Torque Values for General Mounting 21
Trip Finger 7
Trip Unit Assembly 6
Trip Unit Mounting Platform 5